

FIG. 1

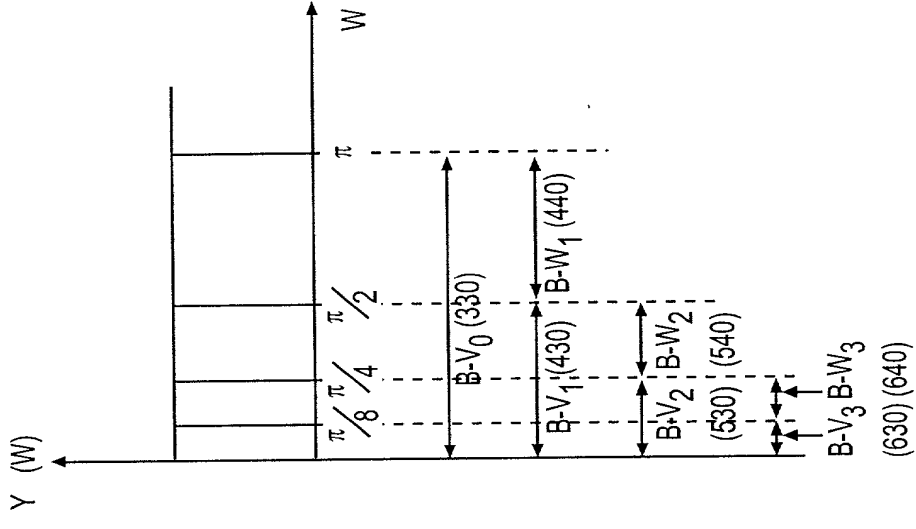

FIG. 3(a)

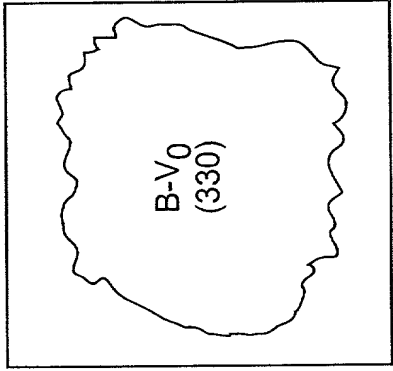

FIG. 2

FIG. 3(b)

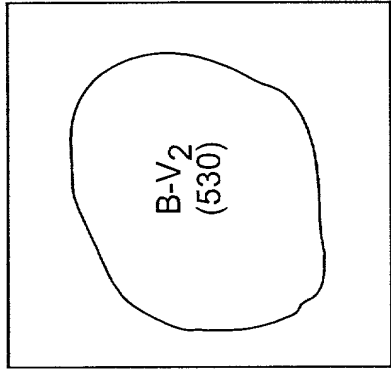

FIG. 4(a)

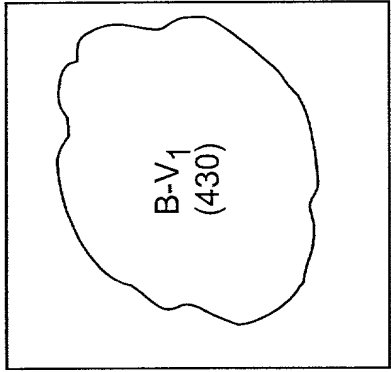

FIG. 4(b)

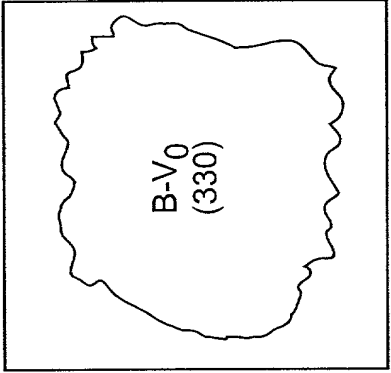

FIG. 4(c)

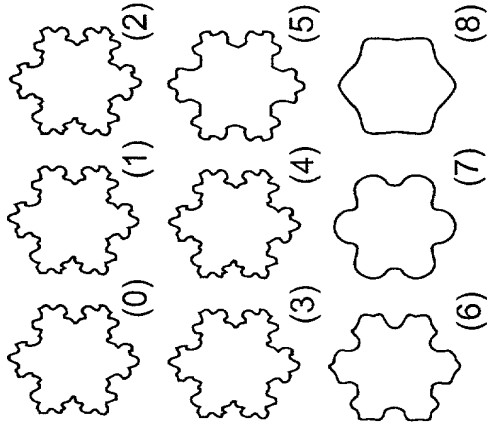
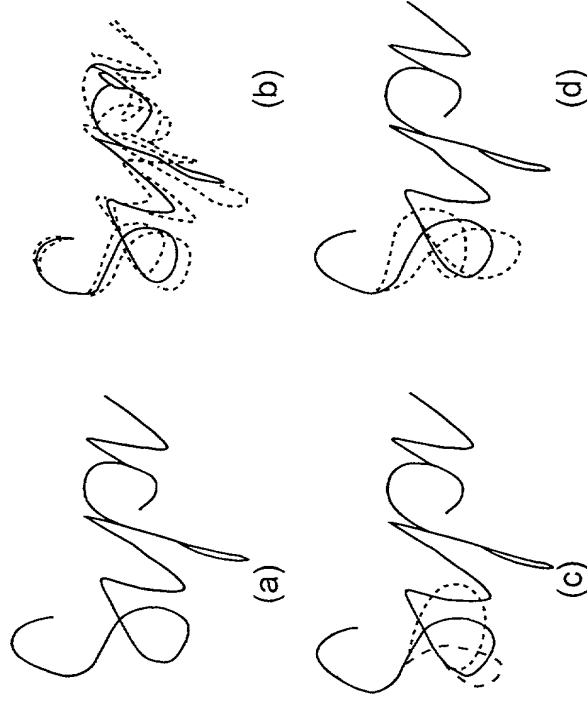

FIG. 5(a)

FIG. 5(b)

$I-V_0$ (310)

FIG. 6(a)

$I-V_1 LL$ (410)	$I-W_1 LH$ (423)
$I-W_1 HL$ (421)	$I-W_1 HH$ (425)

FIG. 6(b)

$I-V_2 LL$ (510)	$I-W_2 LH$ (523)	$I-W_1 LH$ (423)
$I-W_2 HL$ (521)	$I-W_2 HH$ (525)	$I-W_1 HL$ (421)
		$I-W_1 HH$ (425)

FIG. 6(c)

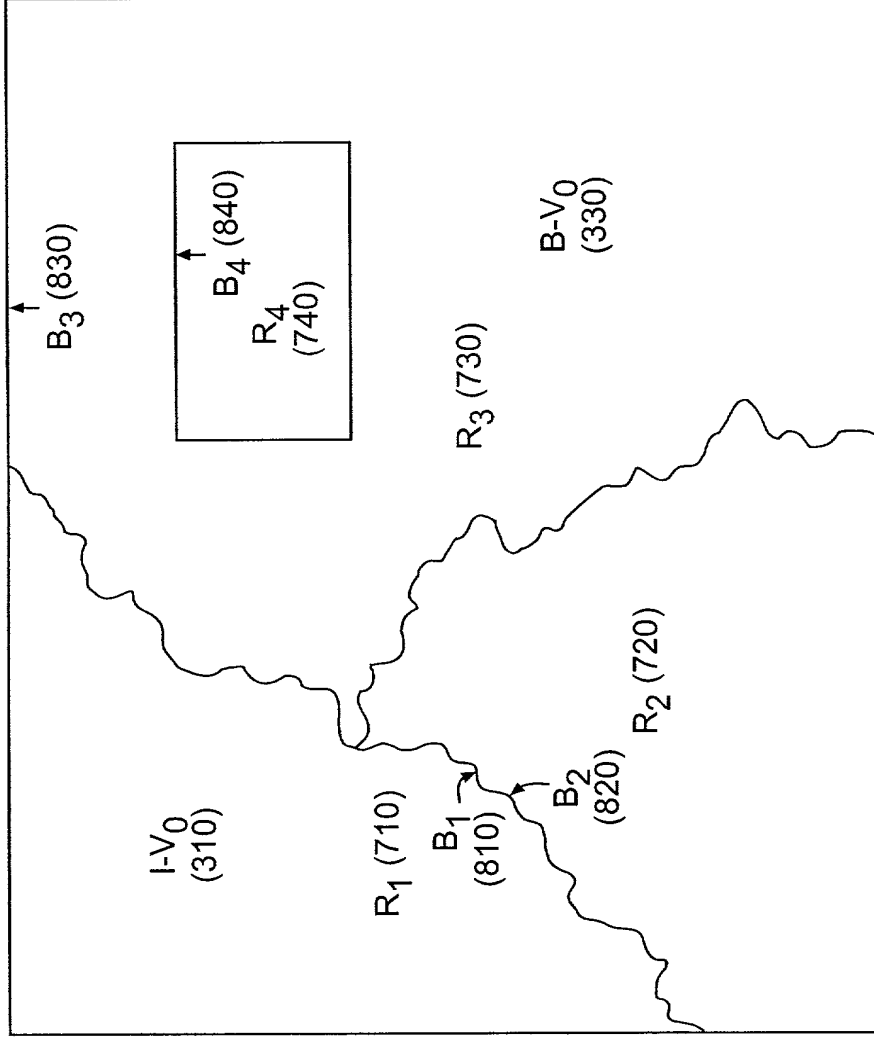

FIG. 7(a)

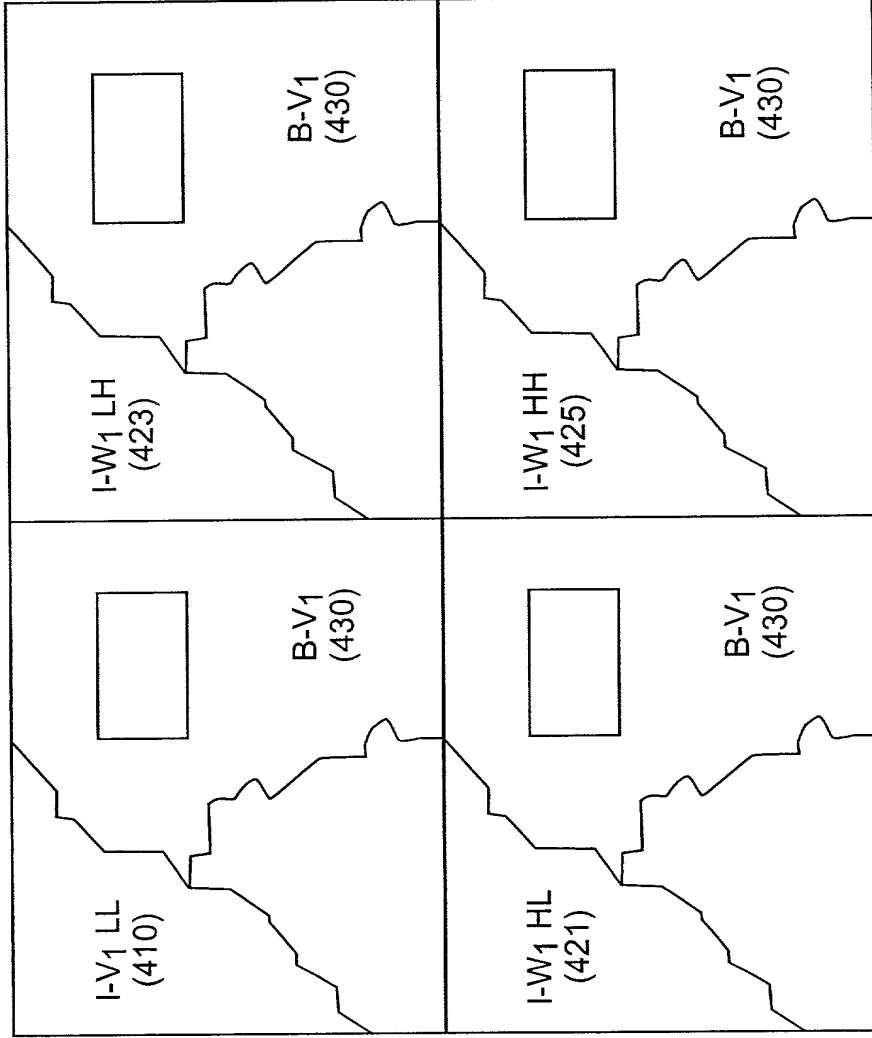

FIG. 7(b)

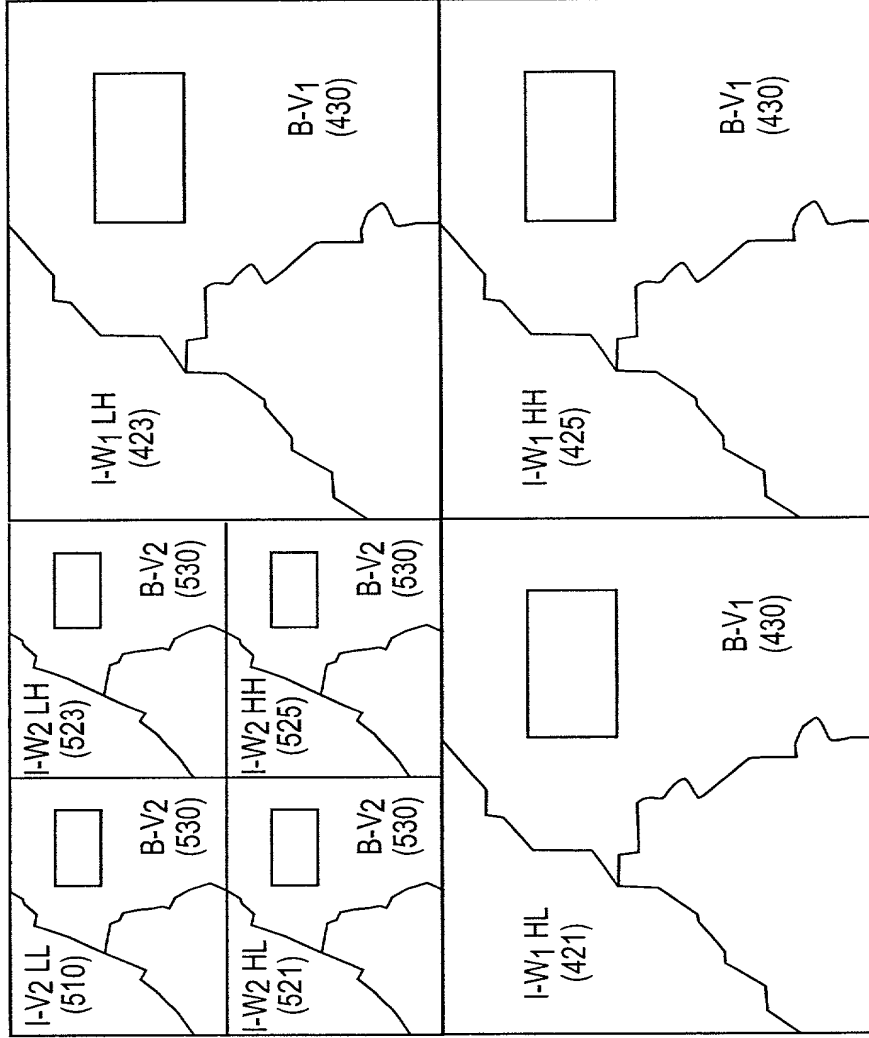

FIG. 7(c)

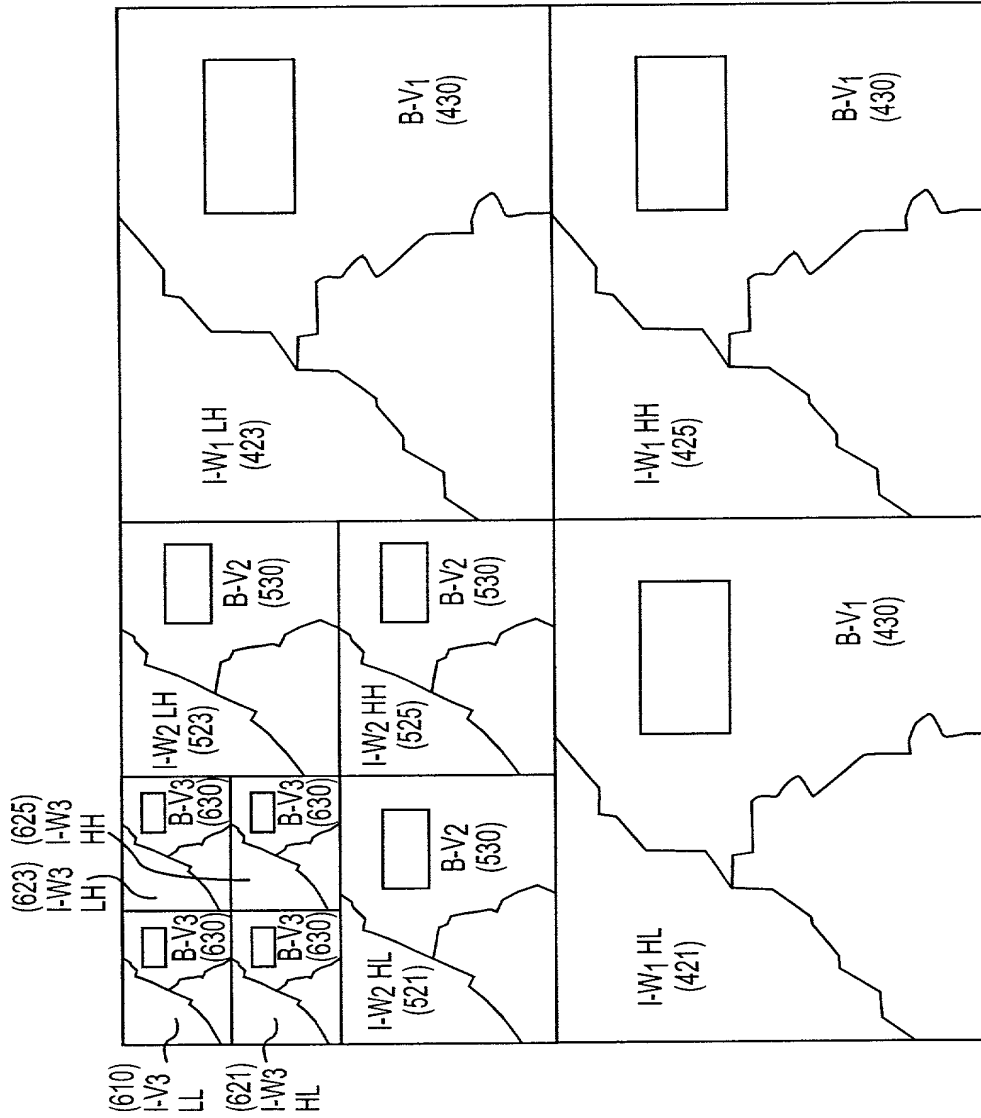

FIG. 7(d)



FIG. 8(a)

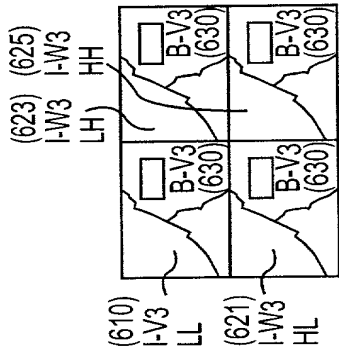

FIG. 8(b)

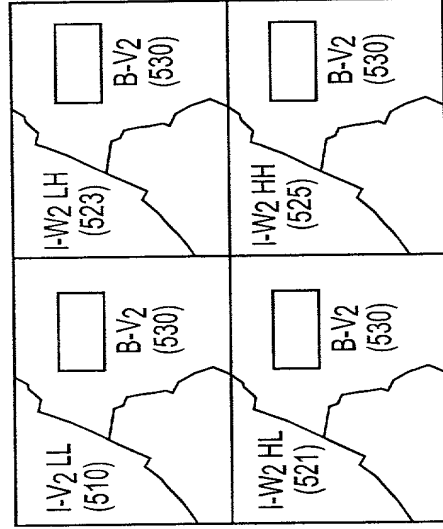

FIG. 8(c)

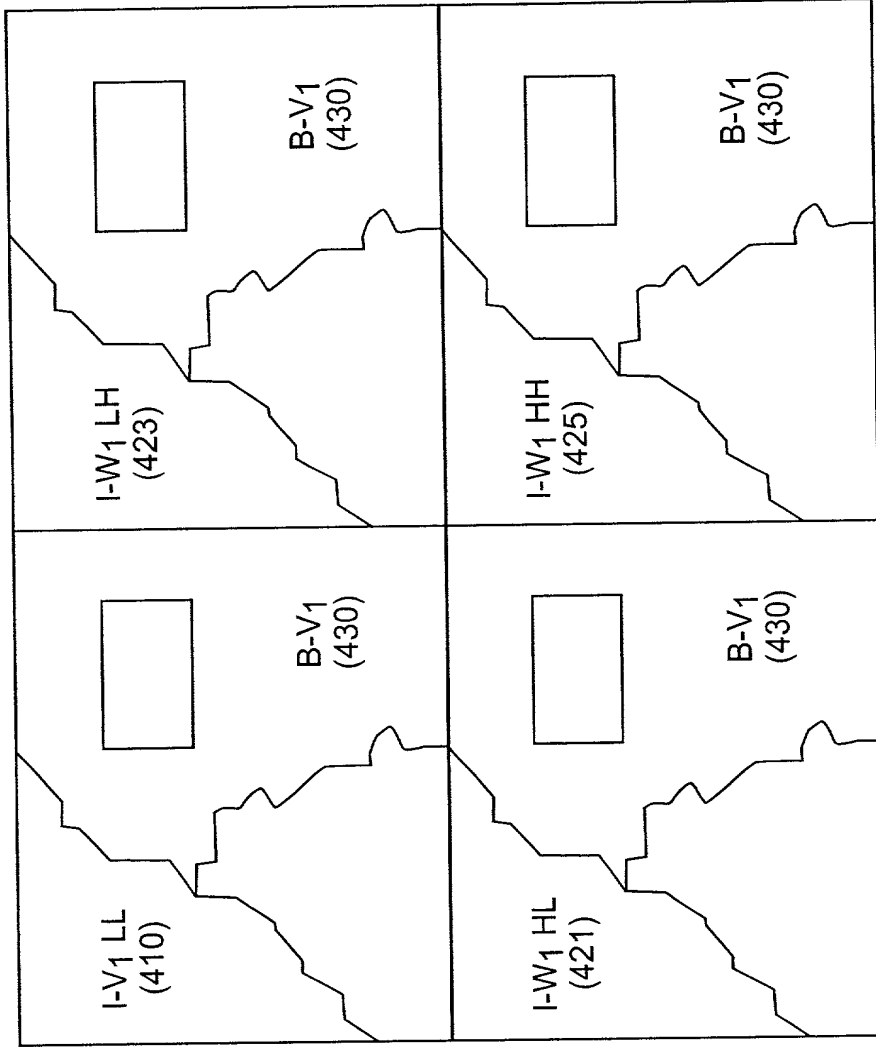

FIG. 8(d)

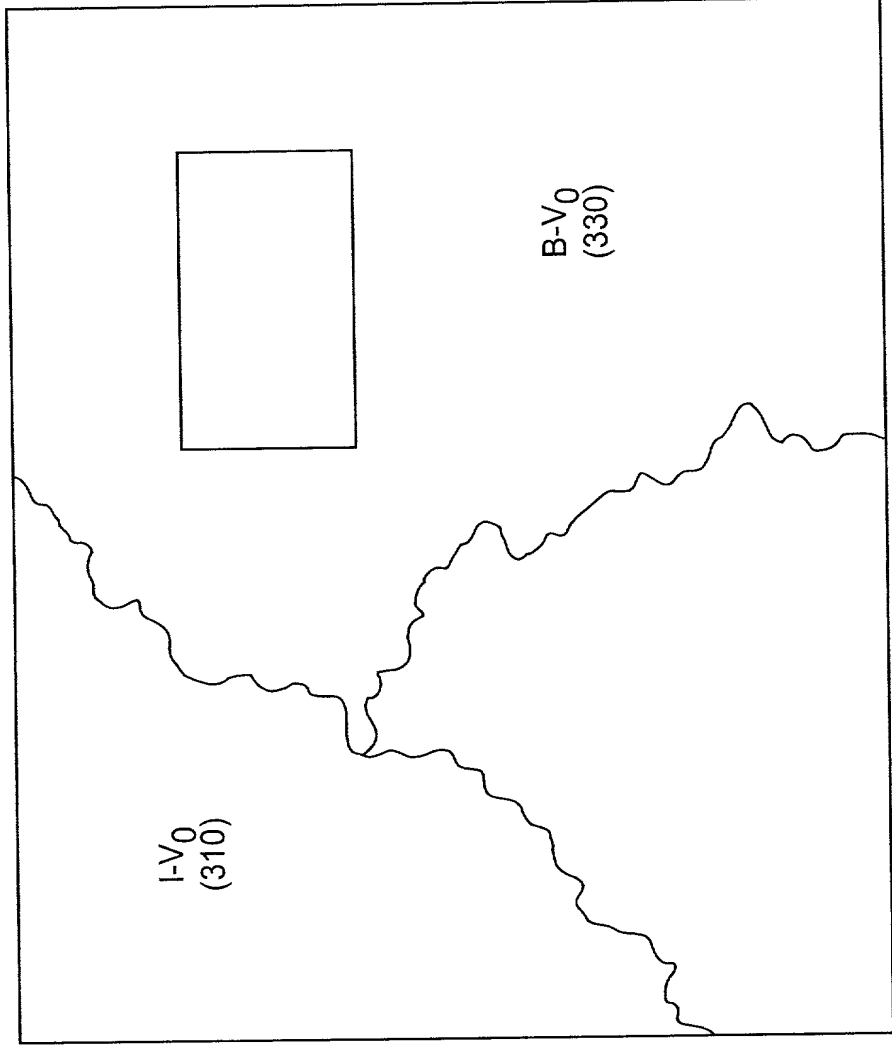

FIG. 8(e)

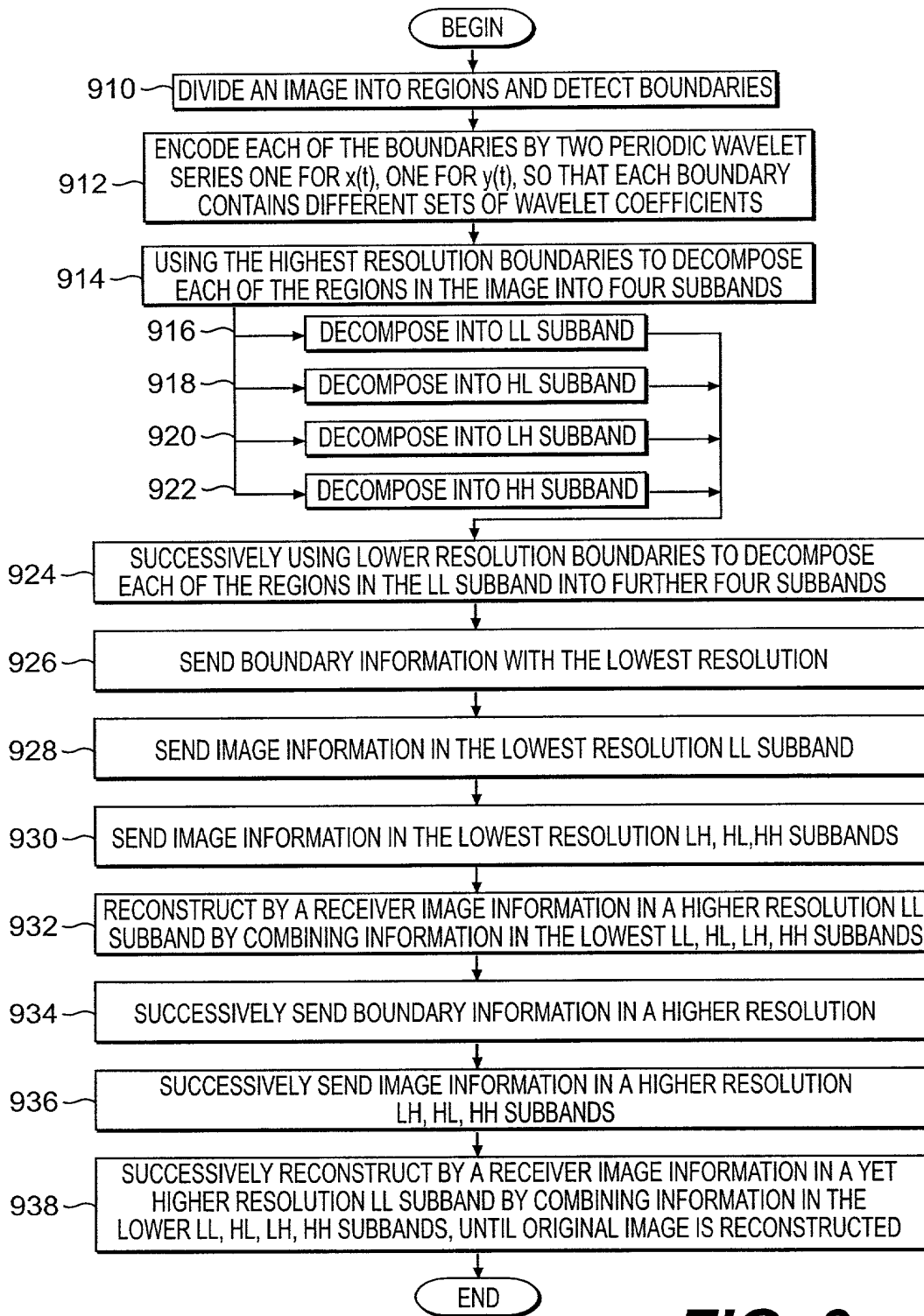

FIG. 9